



Statistical and Artificial Intelligence Based Forecasting Approaches for Cash Demand Problem of Automated Teller Machines

*¹Michele CEDOLIN, ²Deniz ORHAN, ³Müjde GENEVOIS

*¹ Corresponding Author, Department of Industrial Engineering, American University of the Middle East, Kuwait, michele.cedolin@aum.edu.kw 

² Department of Industrial Engineering, Galatasaray University, Türkiye denizorhan012@gmail.com 

³ Department of Industrial Engineering, Galatasaray University, Türkiye, merol@gsu.edu.tr 

Abstract

The efficient management of cash replenishment in Automated Teller Machines (ATMs) is a critical concern for banks and financial institutions. This paper explores the application of statistical and artificial intelligence (AI) forecasting methods to address the cash demand problem in ATMs. Recognizing the significance of accurate cash predictions for ensuring uninterrupted ATM services and minimizing operational costs, we investigate various forecasting approaches. Initially, statistical methodologies including Autoregressive Integrated Moving Average (ARIMA) and Seasonal ARIMA (SARIMA) are employed to model and forecast cash demand patterns. Subsequently, machine learning techniques such as Deep Neural Networks (DNN) and Prophet algorithm are leveraged to enhance prediction accuracy. For the entire data set the average MAPE score obtained with ARIMA is 32.57% while this accuracy increased up to 29.26% with DNN and reached up to 26.77% with Prophet. By optimizing cash replenishment strategies based on accurate forecasts, financial institutions aim to simultaneously enhance customer satisfaction and reduce operational expenses. The findings of this study contribute to a comprehensive understanding of how statistical and AI-driven forecasting can revolutionize cash management in ATMs, offering insights for improving the efficiency and cost-effectiveness of ATM services in the banking sector.

Keywords: Cash Demand; Machine Learning; Forecasting; ARIMA; Prophet

1. INTRODUCTION

The effective organization of various facets is paramount to delivering top-tier service. Our research embarks on tackling a crucial issue, commencing with the identification of an optimal cash replenishment policy. The choice of cash replenishment strategy significantly impacts the overall outcome. Precision in cash predictions is pivotal; forecasts must strike a delicate balance between meeting consumer demands and not immobilizing excess funds in ATMs for extended periods. Achieving an efficient cash inventory management system necessitates harmonizing holding costs with customer service levels. Maintaining excessive inventory translates to substantial financial burdens, yet maintaining an appropriate inventory level is essential to cater to customer cash needs [1].

Hence, formulating a judicious cash management strategy is imperative. One solution involves infusing ATMs with minimal cash, but this approach carries drawbacks such as cash shortages, which lead to customer dissatisfaction—an unfavorable scenario. Conversely, loading ATMs with excessive cash results in idle funds, which, remaining untraded on exchanges, can be construed as a loss for

banks—the second undesirable scenario. Therefore, the objective is to avert over-replenishing cash. The most effective approach to optimize ATM cash management is to strike a balance between these constraints.

This study aims to establish effective forecasting techniques for ATMs. While the literature predominantly relies on conventional methods, the accuracy of predictions profoundly influences customer satisfaction with ATM services. Initially, diverse forecasting methodologies are applied to the NN5 dataset [2], encompassing statistical techniques like Exponential Smoothing, ARIMA and SARIMA [3] [4], alongside machine learning methods like neural networks [5][6]. It is worth noting that Prophet has not been previously applied in the context of ATM cash replenishment policies, differentiating our approach. To evaluate the outcomes, we employ the Mean Absolute Percentage Error (MAPE) metric. Nonetheless, the suitability of these conventional methods for meeting contemporary demands is open to debate. While these methods yield promising results, the adoption of cutting-edge techniques such as the Prophet model can potentially deliver even more efficacious outcomes. This study

illuminates how the utilization of state-of-the-art methods can yield optimal results in today's dynamic environment.

The paper comprises four additional sections. The second section offers a comprehensive review of prior research, the third section elucidates the methodologies and mathematical formulations underpinning our proposed approach, while the final section outlines application and results.

2. LITERATURE REVIEW

Forecasting the precise amount of cash required to meet daily customer demands, ensuring that a minimum cash level remains available until the next replenishment, presents a challenging issue. To address this problem, a data-driven machine learning technique has been employed for forecasting ATM replenishment quantities, offering a more accurate estimation of the optimal cash amount needed for ATM operations [7]. In recent years, machine learning techniques have become the predominant approach for resolving forecasting challenges. Another machine learning algorithm has been devised to address the prediction of daily cash withdrawals from ATMs, harnessing Artificial Neural Networks (ANN) to assert the predictability of daily cash withdrawals for specific ATMs. These cash withdrawals exhibit a seasonal pattern based on date and time parameters [8]. Machine learning methodologies, renowned for their effectiveness in forecasting problems, have witnessed significant advancement in recent times.

Notably, a significant study conducted by Van Anholt and colleagues [9] utilized authentic data from banks to address a multifaceted inventory-routing problem that encompassed pickups and deliveries, drawing inspiration from ATM replenishment procedures in the Netherlands. This research paves the way for advancements in the cash supply chain domain, focusing on enhancing cash management practices and cost reduction. In a parallel vein, Bolduc and co-authors [10] introduce a novel model aimed at minimizing the combined costs associated with transportation and inventory. This model determines which customers will be served by specific distributors and maps out the delivery routes for those handled by the private fleet.

In their study, Simutis and colleagues utilized Artificial Neural Networks (ANN) for predicting the daily cash requirements of 1225 ATMs. These predictions were generated through the integration of weekly and monthly seasonal patterns, as well as long-term trends spanning a two-year period. Furthermore, they introduced an optimization method to determine the most efficient cash replenishment strategy for each ATM. This approach factored in considerations such as cash expenses, uploading costs, and daily service expenses. They assessed the performance of their models in two scenarios, each featuring distinct interest rates and uploading costs, achieving a margin of error of less than 10% [11]. In 2008, Simutis and colleagues employed a versatile Artificial Neural Network (ANN) that incorporated a unique adaptive regularization term derived through cross-validation. Additionally, they utilized the Support Vector Regression (SVR) algorithm to assess the accuracy of forecasting, utilizing both simulated and real data from 15 ATMs over a two-year period. Their

evaluation focused on estimating the Mean Absolute Percentage Error (MAPE) for forecasting the daily cash demand for the subsequent 50 days. The results they obtained ranged from 15% to 28% for the first model and from 17% to 40% for the SVR model [12].

Brentnall and colleagues designed a forward-looking sequential prediction system for managing cash machine replenishment. They favored density forecasts over single-point forecasts and considered various factors such as seasonal patterns, first-order autocorrelation, and cash-out days. Their data was derived from 190 ATMs in the UK, spanning a two-year period. They conducted a comparison of different modeling approaches, including linear models, autoregressive models, structural time series models, and Markov-switching models. They used metrics such as the logarithmic score and continuous ranked probability score (CRPS) to evaluate these models. Their findings indicated that the selection of an appropriate model should be customized for each individual ATM [13].

Teddy and Ng (2011) introduced a novel approach called the pseudo self-evolving cerebellar model articulation controller (PSECMAC) model for forecasting ATM cash demand. They applied this model to a dataset comprising 111 daily ATM cash withdrawal series from the NN5 competition. Initially, they performed data preprocessing and then utilized the Monte Carlo Evaluation Selection (MCES) technique to select relevant features. Their evaluation was based on both one-step ahead and recurrent predictions, with the Symmetric Mean Absolute Percent Error (SMAPE) serving as the error metric. Their results yielded an average SMAPE of 27.25% for one-step ahead prediction and 27.60% for recurrent prediction, surpassing the performance of other global and local learning models [14]. Andrawis and colleagues (2011) meticulously selected nine final models from a vast array of 140 preprocessing combinations. These models were amalgamated to make predictions regarding ATM demand using the NN5 competition dataset. The selected models included the following: standard multilayer neural network, Gaussian process regression, Echo state network, Echo state network ensemble, ARMA, AR, multiple regression, Holt's exponential smoothing, and simple moving average. Initially, they carried out a time aggregation, converting the daily time series data into a weekly format. Following this, a thorough seasonality analysis was conducted, and they applied a deseasonalization method based on medians. The resulting SMAPE errors ranged from 18.94% to 23.77%, with a combined average of 18.95%. This remarkable performance secured them the championship in the NN5 competition among computational intelligence models and the second prize among both statistical benchmarks and computational intelligence models [15]. Venkatesh et al. (2014) focused their attention on identifying a common cash demand pattern among ATMs based on their day-of-the-week activity, with the objective of creating group forecasts. Their approach involved constructing individual time series models for each ATM. To achieve this, they discretized the seven continuous daily withdrawal seasonality parameters and quantified them using the sequence alignment method (SAM). Subsequently, they employed four distinct neural network models: the general regression neural network (GRNN), multi-layer

feedforward neural network (MLFF), group method of data handling (GMDH), and wavelet neural network (WNN) to estimate the cash demand for ATM centers within the NN5 competition dataset. The resulting SMAPE values for all models fell within the range of 18.44% to 21.10%, which is highly promising and among the top-performing results in the existing literature [16]. The outcomes of this study demonstrate an enhancement in the overall forecasting quality of solutions. Fallahtafi et al. (2022) categorized ATMs according to the accessibility and surrounding factors and predicted the cash demand of ATMs before and during COVID-19 pandemic. They concluded that ARIMA and SARIMA may provide high performance for short-term prediction while minimizing overfitting issue [17]. Recently, Sarveswararao et al. (2023) focused on modelling the chaos for Indian Commercial Bank ATMs. They used statistical, machine learning and deep learning techniques in their study and explored the hybrid layer techniques for the overall prediction performance [18].

3. MATERIALS & METHODS

3.1. ARIMA and SARIMA

ARIMA (autoregressive integrated moving average) is a statistical analysis model which employs time series data to optimize the analysis of data or forecast future trends. An autoregressive integrated moving average model is a type of regression analysis that determines how steady one dependent variable is in comparison to other changing variables. An ARIMA model has three constants in terms of p for autoregressive terms, d for the order of differencing, and q for the number of moving-average terms. Generally, ARIMA duration would be expressed as ARIMA (p, d, q) [19]. The general ARIMA model where $d = 1$ can be expressed as

$$Y_t = (1 + \varphi_1)Y_{t-1} + (\varphi_2 - \varphi_1)Y_{t-2} + \dots + (\varphi_p - \varphi_{p-1})Y_{t-p} - \varphi_p Y_{t-p-1} + e_t - \theta_1 e_{t-1} - \theta_2 e_{t-2} - \dots - \theta_q e_{t-q} \quad (1)$$

Moreover, to overcome seasonality in the data SARIMA can be a useful method. SARIMA similarly not also used past data like ARIMA but also consider the seasonality of the pattern as a parameter. SARIMA has become more suitable for forecasting complex data spaces containing trends. SARIMA duration would be expressed (P, D, Q) m where m is the seasonality term. A multiplicative seasonal ARIMA model with non-seasonal orders and seasonal orders with seasonal period, is expressed by.

$$W_t = \nabla^d \nabla_s^D Y_t \quad (2)$$

Khanarsa and Sinapiromsaran (2017), focused on tackling the NN5 forecasting challenge through the application of ARIMA, SARIMA, and exponential smoothing models [20]. SARIMA models applied to certain subseries may be valuable tools in characterizing the structure of daily withdrawals regardless of ATM location, according to the empirical findings [21].

3.2. Deep Neural Network (DNN)

Machine learning plays a significant role in literature when it comes to predicting optimal solutions. Neural networks have gained substantial prominence in the field of machine learning. Artificial Neural Networks (ANNs) and Simulated Neural Networks (SNNs) represent a subset of machine learning techniques that underpin deep learning methodologies. The figure below illustrates a multilayer feed-forward network, wherein each layer of nodes receives input from the preceding layers. A weighted linear combination is employed to amalgamate the inputs for each node. Subsequently, the outcome is modified by a nonlinear function before being presented as the output [22].

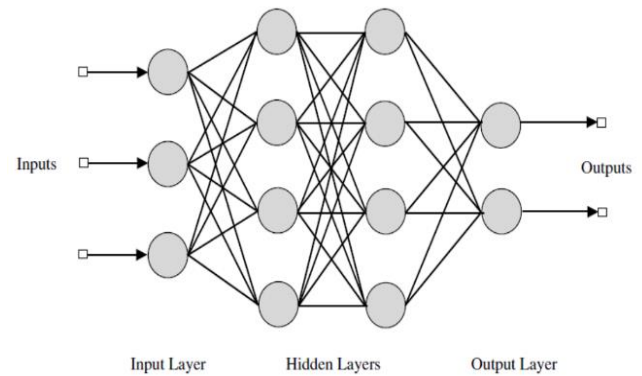

Figure 1. Multilayer Feedforward Neural Network

Figure 1. shows a DNN structure with a configuration of 3-4-4-2, where there are three input nodes and two output nodes. Neural networks offer a viable approach to predict cash demand. Venkatesh et al. (2014) employed four distinct neural networks, namely the General Regression Neural Network (GRNN), Multi-Layer Feed-Forward Neural Network (MLFF), Group Method of Data Handling (GMDH), and Wavelet Neural Network (WNN), to make projections regarding cash demand at ATM centers. Among these models, GRNN emerges as the most effective, as indicated by the SMAPE metric [23]. Atsalaki et al. (2011) employed a Multi-Layer Feed-Forward Neural Network model to predict future values within a set of 100 daily ATM cash withdrawal time series. This model provides outputs that accurately encapsulate the intricate dynamics of the time series data [24].

3.3. Prophet Method

Prophet, an open-source library developed by Facebook, is founded on decomposable models that encompass trends, seasonality, and holidays. Within the realm of machine learning, Prophet stands out as a highly valuable method. Introduced in 2017, it employs a fundamental modular regression model, often yielding satisfactory results with default settings. Moreover, analysts can selectively emphasize the components that are pertinent to their forecasting challenge and adjust as needed, as advocated by Taylor & Letham [25]. Prophet exhibits several distinctive characteristics when compared to other machine learning techniques. Its approach to seasonality and holidays represents a key departure from conventional forecasting

strategies. The model comprises three fundamental components: a trend term, a seasonal period term, and the consideration of holidays. In addition to its exceptional predictive capabilities, Prophet adeptly handles data characterized by periodic and cyclic fluctuations, as well as significant outlier values [26]. Given the multitude of features inherent to ATM data, which encompass seasonal variations and noise, the application of the Prophet method to estimate ATM withdrawals can transcend the limitations of standard forecasting models, yielding superior forecasting outcomes. While literature predominantly employs Prophet for purposes like production planning or sales forecasting, it can also prove to be a suitable solution for our cash demand estimation challenge. The mathematical formulation of Prophet is as

$$y(t) = g(t) + s(t) + h(t) + \varepsilon \quad (3)$$

Where $g(t)$ is a trend item, $s(t)$ is a seasonal change, $h(t)$ is the holiday factor, ε is an error term.

Trend parameters discussed in two ways. The first one is nonlinear growth which reaches a saturation point.

$$g(t) = \frac{c(t)}{1 + \exp(-(k + a(t)^T \delta)(t - (m + a(t)^T \gamma)))} \quad (4)$$

Where $C(t)$ is the time-varying capacity, k is the base rate, m is offset, $k + a(t)^T \delta$ is a growth rate of time varying, to connect the endpoints of segments $m + a(t)^T \gamma$ is adjusted as a offset parameter and δ is the change in the growth rate.

For linear growth, a piece-wise constant rate of growth ensures an efficient model most of the time.

$$g(t) = (k + a(t)^T \delta)t + (m + a(t)^T \gamma) \quad (5)$$

Where k is the growth rate, δ is rate adjustments, m is offset and γ is to make the function continuous [12]. Seasonality models must be expressed as periodic functions of t . To imitate seasonality, Fourier terms are used in regression models by using sine and cosine terms.

$$s(t) = \sum_{n=1}^N \left(a_n \cos \cos \left(\frac{2\pi n t}{P} \right) + b_n \sin \sin \left(\frac{2\pi n t}{P} \right) \right) \quad (6)$$

Where P is the regular period that is expected, 365 for annual data and 7 for weekly data. $N=10$ and $N=3$ for yearly and weekly seasonality work well for most cases.

Some holidays are on certain dates in the year but some of them can vary every year. Therefore, the model needs to fit this change. Resuming that the impacts of vacations are independent. Assign each holiday a parameter κ_i , which is the corresponding change in the prediction, and an indicator function showing whether time t is during holiday i .

$$h(t) = Z(t)\kappa \quad (7)$$

4. APPLICATION & RESULTS

The data consists of two years' worth of daily cash withdrawal records from multiple automated teller machines situated in England. These records are just time series without any additional features or number of instances. These figures are derived from the NN5 competitiveness forecasts. This dataset encompasses 111 randomly selected ATMs located at different sites. The outline of the proposed approach is as follows.

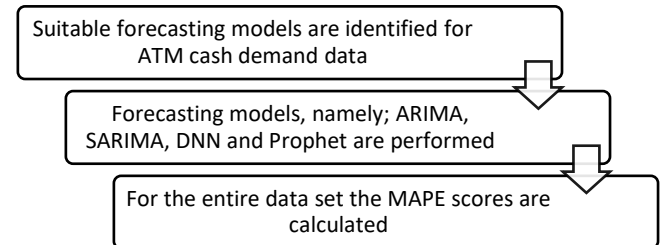

Figure 2. Proposed Approach

All preprocessing, analysis and forecasting models used in this study were implemented in a Colab Jupyter Notebook based on Python using numerous libraries such as TensorFlow and Keras. The algorithms were performed on a computer with a Windows 10 operating system and a CPU Core i7-6700 with 16 GB of memory.

Firstly, the data is preprocessed to be suitable for forecasting models. This preprocess step consists of eliminating the outliers and replacing the missing values. Outliers have the potential to impact both the standard deviation and the average of the dataset, introducing potential inaccuracies in forecasting models. Therefore, it's important to carefully examine the trend and seasonality of the data during preprocessing. When the data is stationary, missing values can be replaced with the arithmetic mean of the entire series. However, if there is a discernible trend, alternatives like the median or mode can be used for replacement. Typically, outliers are identified and removed by employing quartile values. Figure 3. depicts the box plot for the reduced NN5 data set.

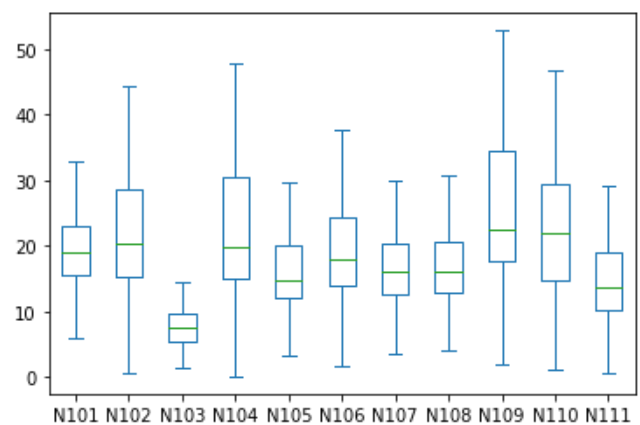

Figure 3. Box Plot for the Reduced Data Set

The subsequent phase in the forecasting process involves computing the autocorrelation (also known as serial correlation) and partial autocorrelation of the dataset.

Autocorrelation evaluates the impact of past observed values on the current value, in contrast to partial autocorrelation, which specifically measures the influence of recent observations on the current value. The term "lag" represents the number of prior observations considered in autocorrelation. The determination of the autoregressive and moving average process order is based on the autocorrelation function (ACF) and partial autocorrelation function (PACF). Figure 4. And Figure 5. display the ACF and PACF charts for the first ATM, respectively.

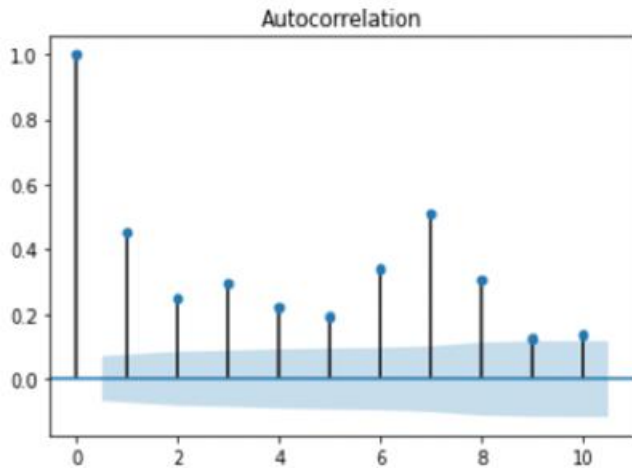

Figure 4. ACF values of the first ATM

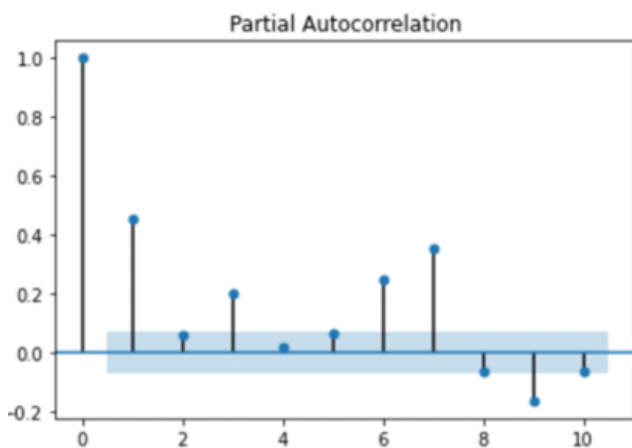

Figure 5. ACF values of the first ATM

The most pronounced correlations in both functions occur at a lag of seven, which can be directly attributed to the significant weekly seasonality of the dataset. This means that the day of the week plays a crucial role in the calculation process, indicating that the demand on Tuesdays and the demand on the following Tuesdays tend to exhibit similar patterns. These calculations were performed for each individual series, and in each case, the highest correlation value was observed at a lag of seven.

For addressing issues related to ATM cash replenishment, various methods are available, such as statistical approaches,

machine learning techniques, and hybrid approaches. Following a thorough examination of existing literature, the seasonality parameter, which holds significance in our specific dataset, led us to choose the SARIMA approach over statistical alternatives. Within the realm of machine learning, there is a wide array of neural network models, with the most used ones being the Artificial Neural Network (ANN) and Deep Neural Networks (DNN) demonstrating superior performance among other neural network techniques. Additionally, we also employed the most recent machine learning technique called Prophet in this study. Our approach, which compares ARIMA-SARIMA-DNN-Prophet, effectively handles the forecasting of cash quantities.

In our machine learning process, the model structure is established, permitting a maximum of three hidden layers. In neural networks, a hidden layer is positioned between the algorithm's input and output layers. Within this layer, the algorithm applies weights to the inputs and processes them through an activation function to produce the output. In essence, these hidden layers carry out nonlinear transformations on the input data fed into the network. It's worth noting that having an excessive number of hidden layers can significantly prolong the training process, to the extent that adequately training the neural network becomes impractical. Moreover, it can lead to overfitting, where the network memorizes the data instead of learning from it, resulting in poor performance when applied to test data. The chosen optimization method is Stochastic Gradient Descent (SGD) with a momentum, which consumes less memory than the traditional Gradient Descent (GD) algorithm. This is because SGD computes the derivative by considering only one data point at a time, and it achieves faster convergence thanks to the incorporation of momentum. Rectified Linear Unit (ReLU) is used as the activation function. Following table illustrates the hyperparameter tuning set used in the grid search for finding the best DNN settings.

Table 2. Hyperparameter Set for DNN

Window Size	range (7,28, step=7)
Batch Size	range (5,50, step=5)
Learning Rate	[1e-6, 1e-5, 1e-4]
Momentum	[0.3, 0.6, 0.9]
Epochs	range (100,500, step=50)

We opted to employ the model to predict the forthcoming 56 days by utilizing data from the initial 735 days. Training data and test data split is based on the NN5 competition requirement where researchers are asked to predict the next 56 days demand based on the given training data. We utilize the initial cash amount for a randomly selected ATM 103 as a reference point for comparing these processes in the chart below.

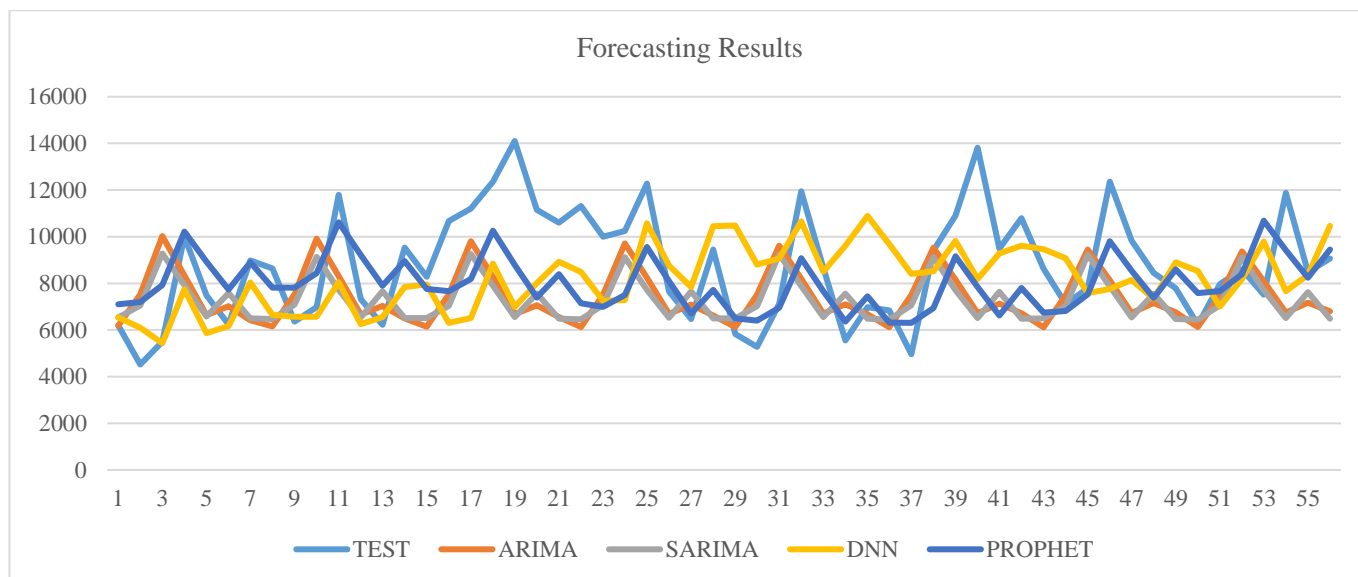

Figure 6. Forecasting outcomes for ATM 103

Where we see that Prophet model outperforms all the remaining models for ATM 103. Similarly, we performed all the forecasting models for the reduced data set, and we obtained the average MAPE scores below.

Table 3. MAPE Scores

Model	Average	St. Dev.	Median
ARIMA	32.57	22.03	26.29
SARIMA	33.69	22.05	27.78
DNN	29.26	16.70	25.49
PROPHET	26.77	14.59	23.50

As it is in Table 3., Prophet is the best forecasting model overall, followed by DNN. Figure 7 depicts the MAPE boxplots for all the series where the distributions of the errors may be observed.

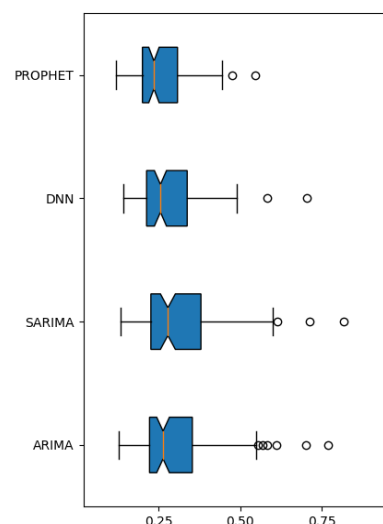

Figure 7. MAPE Boxplot

5. CONCLUSION

To sum up, in this study a decision support system has been developed to address the issue of ATM cash replenishment. Various methods have been thoroughly assessed from different angles, and their outcomes have been scrutinized using a metric system. The method with the lowest error rate was chosen.

In this study, the ARIMA, SARIMA, DNN and Prophet forecasting methods are employed. Machine learning based models increased accuracy significantly while reducing standard deviation among the series performance. We showed the significance of this problem and the importance of optimizing it through numerous benchmark scenarios from the existing literature.

Furthermore, as part of future work, the Vehicle Routing Problem (VRP) can be applied based on the forecasts generated by Prophet, ultimately leading to cost minimization. This approach aims to provide practical and effective solutions within the banking industry.

Author contributions:

Conflict of Interest: No conflict of interest was declared by the authors.

Financial Disclosure: The authors declared that this study has received no financial support.

REFERENCES

- [1] Baker, T., Jayaraman, V., Ashley, N. "A Data-Driven Inventory Control Policy for Cash Logistics Operations: An Exploratory Case Study Application at a Financial Institution," 2013, pp. 205-226.
- [2] <http://www.neural-forecasting-competition.com/NN5/> Retrieved October 19, 2023.
- [3] Catal, C., Fenerci, A., Ozdemir, B., & Gulmez, O. (2015). Improvement of demand forecasting models with special days. *Procedia Computer Science*, 59, 262-267.

- [4] Cedolin, M. and Erol Genevois, M. (2021), "An averaging approach to individual time series employing econometric models: a case study on NN5 ATM transactions data", *Kybernetes*, 51(9), 2673-2694.
- [5] Zapranis, A., & Alexandridis, A. (2009). Forecasting cash money withdrawals using wavelet analysis and wavelet neural networks. *International Journal of Financial Economics and Econometrics*.
- [6] Garcia-Pedrero, A., & Gomez-Gil, P. (2010, February). Time series forecasting using recurrent neural networks and wavelet reconstructed signals. In 2010 20th International Conference on Electronics Communications and Computers (CONIELECOMP) (pp. 169-173). IEEE.
- [7] Asad, M., Shahzaib, M., Abbasi, Y., and Rafi, M. "A Long-Short-Term-Memory Based Model for Predicting ATM Replenishment Amount," in 2020 21st International Arab Conference on Information Technology (ACIT), Information Technology (ACIT), 2020 21st International Arab Conference On, 2020, 1–6. <https://doi.org/10.1109/ACIT50332.2020.9300115>
- [8] Serengil, S. I., Özpınar, A., "ATM Cash Flow Prediction and Replenishment Optimization with ANN," 2019, pp. 402-408.
- [9] R. G. Anholt, L. C. Coelho, G. Laporte and I. F. A. Vis "An Inventory-Routing Problem with Pickups and Deliveries Aising in the Replenishment of Automated Teller Machines," 2016, pp. 1077-1091.
- [10] Bolduc, M.-C., Laporte, G., Renaud, J., and Boctor, F. F. "A tabu search heuristic for the split delivery vehicle routing problem with production and demand calendars," 2010, *European Journal of Operational Research*, 202(1), 122–130.
- [11] Simutis, R., Dilijonas, D., & Bastina, L. (2008). Cash demand forecasting for ATM using neural networks and support vector regression algorithms. 20th International Conference, Euro Mini Conference Continuous Optimization and Knowledge-Based Technologies, 416-421.
- [12] Simutis, R., Dilijonas, D., Bastina, L., & Friman, J. (2007). A flexible neural network for ATM cash demand forecasting. *Cimmacs '07: WSEAS International Conference on Computational Intelligence, Man-Machine Systems and Cybernetics*, 163-168.
- [13] Brentnall, A. R., Crowder, M. J., & Hand, D. J. (2010a). Predicting the amount individuals withdraw at cash machines using a random effects multinomial model. *Statistical Modelling*, 10(2), 197-214.
- [14] Teddy, S. D., & Ng, S. K. (2011). Forecasting ATM cash demands using a local learning model of cerebellar associative memory network. *International Journal of Forecasting*, 27(3), 760-776.
- [15] Andrawis, R. R., Atiya, A. F., & El-Shishiny, H. (2011). Forecast combinations of computational intelligence and linear models for the NN5 time series forecasting competition. *International Journal of Forecasting*, 27(3), 672-688.
- [16] Venkatesh, K., Ravi, V., Prinzie, A., & Van den Poel, D. (2014). Cash demand forecasting in ATMs by clustering and neural networks. *European Journal of Operational Research*, 232(2), 383-392.
- [17] Fallahtafti, A., Aghaaminiha, M., Akbarghanadian, S., & Weckman, G. R. (2022). Forecasting ATM cash demand before and during the COVID-19 pandemic using an extensive evaluation of statistical and machine learning models. *SN Computer Science*, 3(2), 164.
- [18] Sarveswararao, V., Ravi, V., & Vivek, Y. (2023). ATM cash demand forecasting in an Indian bank with chaos and hybrid deep learning networks. *Expert Systems with Applications*, 211, 118645.
- [19] Box, G. E. P., Jenkins, G. M. and Reinsel, G. C. (1994). *Time Series Analysis, Forecasting and Control*, Prentice Hall, Englewood Cliffs, N.J.
- [20] Khanarsa, P., Sinapiromsaran, K. "Multiple ARIMA subsequences aggregate time series model to forecast cash in ATM. 9th International Conference on Knowledge and Smart Technology: Crunching Information of Everything," 2017, 83–88. <https://doi.org/10.1109/KST.2017.7886096>
- [21] Gurgul, H., Suder, M. "Modeling of Withdrawals from Selected ATMs of the "Euronet" Network," 2013, pp. 65-82.
- [22] Hyndman, R.J., Athanasopoulos, G. "Forecasting: principles and practice," 2nd edition, 2018, OTexts: Melbourne, Australia. [OTexts.com/fpp2](https://www.otexts.com/fpp2). Accessed on 1.06.2022.
- [23] Venkatesh, K., Ravi, V., esd. "Cash Demand Forecasting in ATMs by Clustering and Neural Networks," 2014, pp. 383-392.
- [24] Atsalaki, I. G., Atsalakis, G. S., and Zopounidis, C.D. "Cash withdrawals forecasting by neural networks," *Journal of Computational Optimization in Economics and Finance*, 3(2), 2011, pp. 133-142.
- [25] Taylor, S. J., & Letham, B. "Prophet: Forecasting at scale," 2017, pp. 37-45.
- [26] Wang, D., Meng, Y., Chen, S., Xie, C., and Liu, Z. "A Hybrid Model for Vessel Traffic Flow Prediction Based on Wavelet and Prophet," 2021, pp. 1-16.